

01. November 2017

DALLMER

floor drain TistoStone VN 15, DN 50, 150 x 150 mm

Product Number: **516299**
EAN: 4001636516299
Discount group: 5

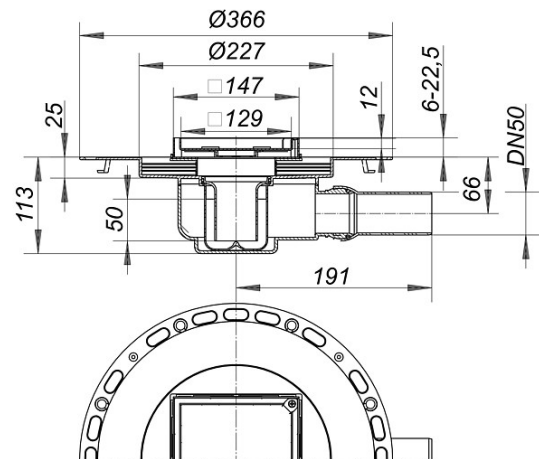

conforming to DIN EN 1253
floor drain with a stainless steel grating for tiling with customers floor finish
outlet DN 50 horizontal, with ball-joint, adjustable 0 – 15 degrees

specification:

- flange with fleece surface
- Tisto-membrane
- removable trap insert, 50 mm water seal
- temporary blanking plate
- grating laterally adjustable +/- 4 mm, height adjustable for floorings 6 – 22 mm (incl. adhesive)

material:

polypropylene

grating 304 stainless steel, screwable, 150 x 150 mm